

inch

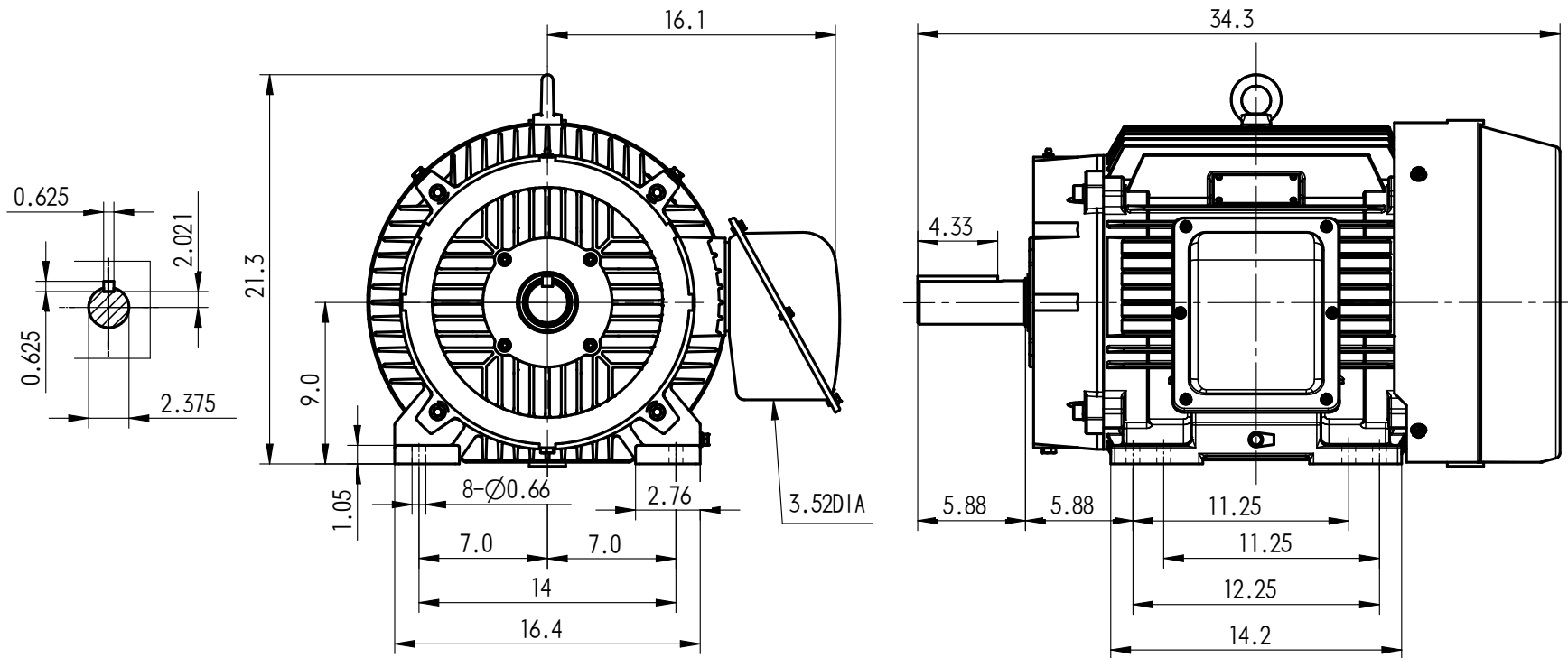

FRAME **365T Footed**